



TSA 042

VIDEO ALARM SEQUENTIAL SWITCHER

CONTENTS

Safety precautions	2
Preface	3
Features	3
Precautions	3
Controls and connectors	4
Connections	5
Alarm connection	7
VCR CLOCK connection	7
Vertical interval switching	7
Alarm specification	7
Remote control	7
Set-up	8
Standard setting	10
Self test	10
Installation	10
Appearance	11
Specifications	11
Optional accessory	12

SAFETY PRECAUTIONS

In order to prevent any fatal accidents caused by misoperation or mishandling of the video switcher, be fully aware of all the following precautions.

WARNING:
This is a Class A product. In a domestic environment this product may cause radio interference in which case the user may be required to take adequate measures.

WARNING:
THIS APPARATUS MUST BE EARTHED

To prevent fire or shock hazard, do not expose this appliance to rain or moisture.

This unit is produced to comply with Directives 93/68/EEC (IEC Publ.65) and 89/336/EEC.

WARNING:



CAUTION

RISK OF ELECTRIC SHOCK
DO NOT OPEN



CAUTION:
 TO REDUCE THE RISK OF ELECTRIC SHOCK, DO NOT REMOVE COVER.
 NO USER SERVICEABLE PARTS INSIDE. REFER SERVICING TO QUALIFIED
 SERVICE PERSONNEL.





The lightning flash with arrowhead symbol, within an equilateral triangle, is intended to alert the user to the presence of uninsulated "dangerous voltage" within the product's enclosure that may be sufficient magnitude to constitute a risk of electric shock to persons.



The exclamation point within an equilateral triangle is intended to alert the user to the presence of important operating and maintenance (servicing) instruction in the literature accompanying the product.

PREFACE

The TSA 042 is a high quality microprocessor based video switcher which is suitable to connect up to four cameras or other video sources. Two independent outputs allow to connect the main monitor and the video tape recorder with optional clock output. Alarm input is suitable to connect four alarm sensors. Standard BNC-type input and output connectors enables the TSA 042 to be used with other CCTV switchers, cameras, monitors and video tape recorders.

FEATURES

- Microprocessor based
- 4 video inputs
- 2 video outputs
- 4 alarm inputs
- Alarm output
- VCR-CLOCK input
- Frame-by-frame switching
- Vertical interval switching
- Built-in buzzer
- Nonvolatile RAM backup
- Remote control possibility
- Rack mountable using optional rack mount kit

PRECAUTIONS

- Use only the power source specified on the rating label located on rear of the cabinet.
- When not using this unit for a long period of time, or when cleaning it, be sure to disconnect the power plug from the AC outlet.
- Do not drop metallic parts through slots. This action could permanently damage this unit. Do turn power off immediately and refer servicing to qualified service personnel.
- Avoid using this unit under the following conditions:
 - in extremely hot, cold or humid places,
 - in dusty places,
 - near appliances generating strong magnetic fields,
 - in places subject to direct sunlight, and
 - in badly ventilated places.
- Unplug this unit from the AC outlet and refer servicing to qualified service personnel under the following conditions:
 - when the power cord is frayed or plug is damaged
 - if the unit does not operate normally following the operating instructions
 - if the unit has been dropped or the cabinet has been damaged
 - when the unit exhibits a distinct change in performance.

CONTROLS AND CONNECTORS

FRONT PANEL

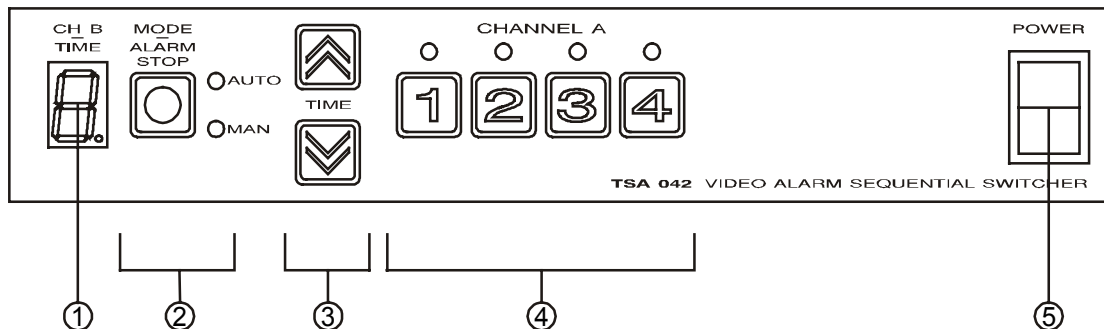

(1) CH B - TIME

LED display to show the sequence of the CHANNEL B or the sequential time of the CHANNEL A.

When the VCR CLOCK is selected the display shows C. When the frame-by-frame mode is selected the display shows F. When one of the TIME keys is pressed a decimal point lights and the display shows the selected sequential time - 0 for 1 to 9 seconds, 1 for 10 to 19 seconds etc. When an alarm occurs and the CHANNEL B is selected the decimal point blinks.

(2) MODE - ALARM STOP

Key to select operating mode - auto (sequential) or manual - or to reset the alarm when the CHANNEL A is selected.

(3) TIME

Keys to adjust the sequential time from 1 to 90 seconds.

(4) CHANNEL A

Keys to select the input signals in manual mode or to eliminate the inputs in auto (sequential) mode.

In manual mode red LED lights at selected input, in auto (sequential) mode red+green LED lights at selected input. If all the inputs are eliminated, the switcher automatically switches the first input.

(5) POWER

Switch to turn the power on / off - lights in the power on position.

REAR PANEL

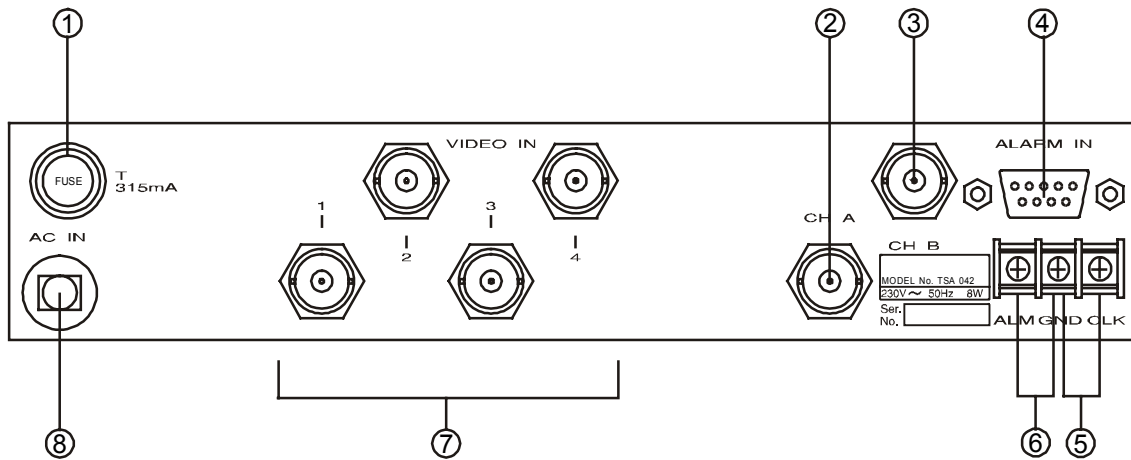

(1) FUSE T 315 mA

Fuse socket.

(2) CH A

BNC video output connector of the CHANNEL A. It is suitable to connect the main monitor.

(3) CH B

BNC video output connector of the CHANNEL B. It is suitable to connect the video tape recorder optionally with CLOCK output.

(4) ALARM IN

Alarm input / remote control connector (D-9F). It allows to connect up to four alarm sensors. When the remote control possibility is used all the alarm inputs are inactive.

(5) CLK

VCR-CLOCK input connector (terminal block). When the video tape recorder with CLOCK output is used and connected to the VCR-CLK input, the sequence of the CHANNEL B will depend on the CLOCK pulse. In the SET-UP, VCR-CLOCK input has to be selected.

(6) ALM

Alarm output connector (terminal block), open collector output. It is suitable to connect the video tape recorder with alarm input.

(7) VIDEO IN

BNC video input connectors. They allow to connect up to four video cameras or other video sources.

(8) AC IN

Power cord.

CONNECTIONS

- Be sure to disconnect the power plug from the AC outlet before connecting to other equipment.
- Also refer to the instruction manual of the equipment to be connected.

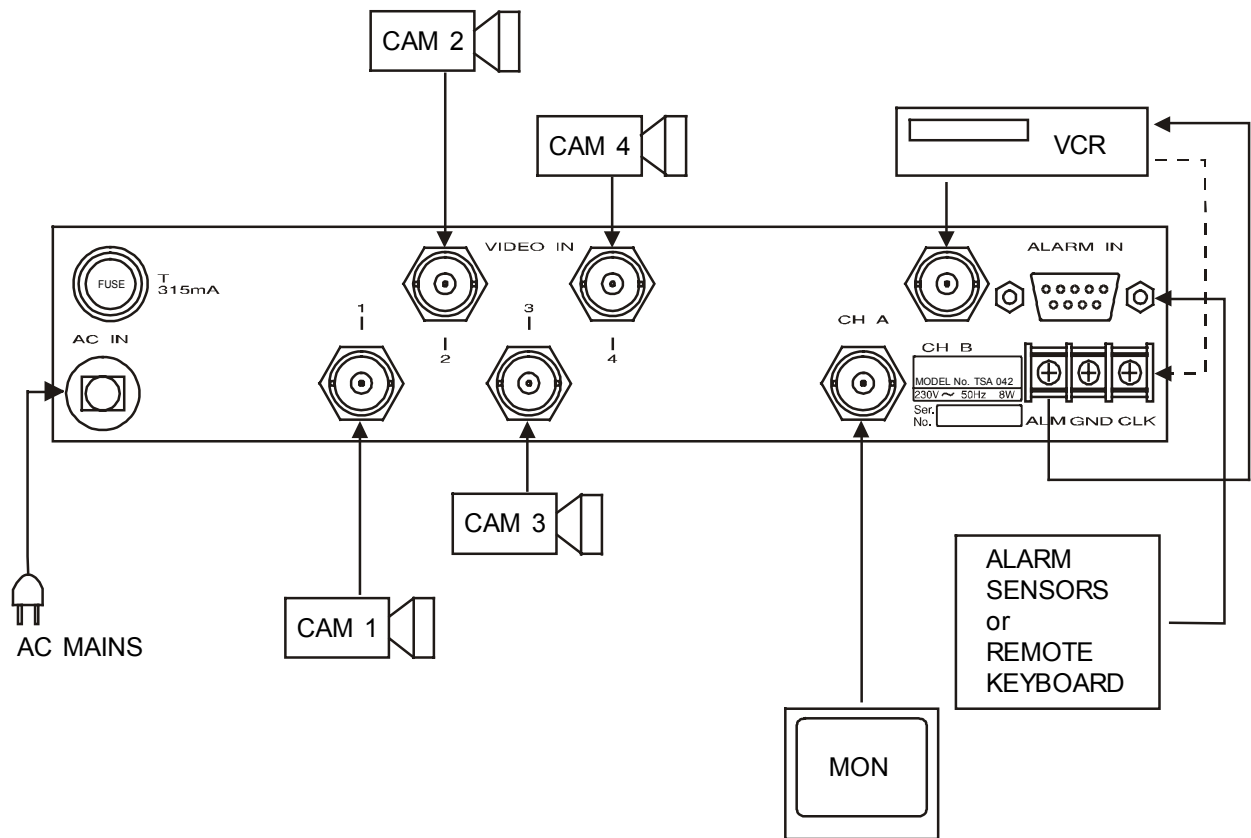

ALARM / REMOTE CONTROL CONNECTION

Connection diagram:

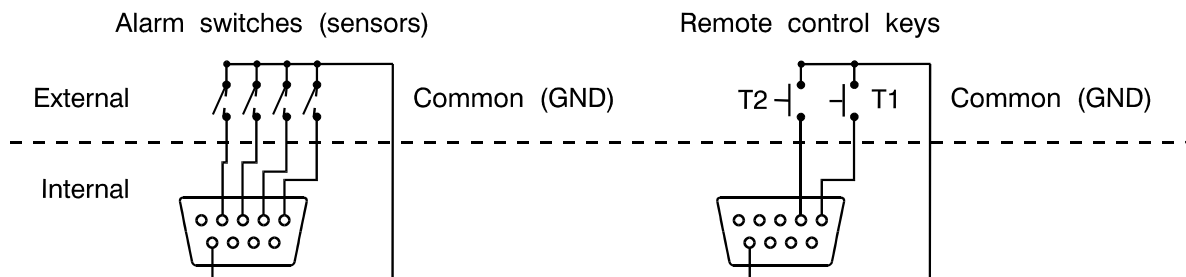

Notes:

- Negative triggering - all alarm switches must be opened, in case of alarm they are closed.
- Positive triggering - all alarm switches must be closed, in case of alarm they are opened.

Notes:

- T1 - start/stop key
- T2 - manual scan key

VCR-CLOCK CONNECTION

The VCR-CLK input is a standard TTL negative triggered input (5V to 0V)



Note:

- If the VCR CLOCK pulse is 12V, set the jumper J102 to 12V position.

VERTICAL INTERVAL SWITCHING

This unit includes an electronic circuit which allows smooth switchings without picture roll or flutter. When the cameras and this unit are line-locked this function appears. Line-lock phase is adjustable in ± 127 steps. (± 2.2 ms)

ALARM SPECIFICATION

When only one alarm input is activated, the alarmed video input appears on the CHANNEL A or CHANNEL B. Buzzer is activated. On the CHANNEL A auto and manual LEDs blink. When the CHANNEL B is selected the decimal point on the LED display blinks. Alarm output is activated (switched to the ground). When more than one alarm input is activated, the alarmed video inputs appear on the CHANNEL A or CHANNEL B sequentially.

The CHANNEL B is automatically switched from sequential mode to frame-by-frame mode when the ALARM FRAME SWITCHING is enabled. This function is disabled when the VCR CLOCK is selected.

Alarm sequential time and alarm duration time are adjusted in the SET-UP. With pressing the key ALARM STOP manual reset of the alarm is achieved on the CHANNEL A.

REMOTE CONTROL

Remote control possibility on the CHANNEL A appears when the auto (sequential) mode is selected. Key T1 is used to stop and start the auto sequence. When it is stopped key T2 is used for manual scan. In the set-up, REMOTE CONTROL has to be selected.

SET-UP

Set-up is made by the help of the LED display located on the front panel of the unit. Numerical codes are used to locate the selected setting. All settings are as follows:

- 1 - CHANNEL B mode (normal, VCR-CLOCK, frame-by-frame)
- 2 - CHANNEL B sequential time (1 - 90 sec.)
- 3 - CHANNEL B number of inputs (1 - 4)
- 4 - CHANNEL B frame number (1 - 99 frames)
- 5 - ALARM activity (CH-A, CH-B, off)
- 6 - ALARM sequential time (1 - 90 sec.)
- 7 - ALARM duration time (1 - 90 sec.)
- 8 - ALARM frame switch (on/off)
- 9 - ALARM triggering (negative/positive)
- A - REMOTE CONTROL (on/off)
- b - LINE LOCK PHASE(-127 to +127)
- C - SAVE the SET-UP (yes/no)

Switch off the unit. Press the key "4" and turn the power on. All LED lamps go off, power switch lights. In the LED display number

"1" (CHANNEL B mode)

is appeared.

Press "•":

"0." (mode selecting)

The dot in the right corner is appeared, adjusting is allowed. Use keys "∨" and "∧" to select the CHANNEL B mode. The dot in the right corner is blinking, the LED display shows the selected mode - "0" for normal mode, "1" for VCR-CLOCK and "2" for frame-by-frame switching.

Press "•" to return to main settings. Press "∧" to select next setting:

"2" (CHANNEL B seq. time)

Press "•":

"0." (seq. time adjusting)

Set the number of inputs by pressing up/down selectors. The LED display shows the selected sequential time - "0" for 1 to 9 sec., "1" for 10 to 19 sec. etc.

Press "•", select the next setting:

"3" (CHANNEL B number of inputs)

Press "•":

"4." (set the number of inputs by pressing up/down selectors))

Press "•", select the next setting:

"4" (CHANNEL B frame number)

Set the number of frames by pressing up/down selectors.
Press "•", select the next setting:

"5" (ALARM activity)

Select "0." for "off" and "1." for CHANNEL A or "2." for CHANNEL B.
Press "•", select the next setting:

"6" (ALARM seq. time)

Adjust sequential time by pressing up/down selectors.
Next setting:

"7" (ALARM duration time)

Adjust alarm duration time by pressing up/down selectors.
Next setting:

"8" (ALARM frame switch)

Select "0." for "off" and "1." for "on".
Select the next setting:

"9" (ALARM triggering)

Select "0." for negative triggering and "1." for positive triggering on the LED display.
Next setting:

"A" (REMOTE CONTROL)

Select "0." for "off" and "1." for "on".
Next setting:

"b" (LINE LOCK PHASE)

Adjust line-lock phase by pressing "•":

LED 1 lights, LED display shows polarity - "0." for negative and "1." for positive, press "•":

LED 2 lights, LED display shows "0" for 0xx to 0yy steps, "1" for 1xx to 1yy steps, press "•":

LED 3 lights, LED display shows "0" for x0x to y0y steps, "1" for x1x to y1y steps etc., press "•":

LED 4 lights, LED display shows "0" for xx0 to yy0 steps, "1" for xx1 to yy1 steps etc., press "•":

Next setting:

"C" (SAVE the SET-UP)

Press "•":

"-."

Select "1." or "0." for saving or not saving the new SET-UP.
Select "-." to return to SET-UP.

STANDARD SETTING

Switch off the unit. Press the key "1" and turn the power on. All settings are as follows:

CHANNEL A: -auto (sequential) mode
 -4 inputs
 -seq. time - 1 sec.
CHANNEL B: -sequential mode
 -seq. time - 1 sec.
 -4 inputs
 -1 frame
ALARM: -activity - off
 -seq. time - 1 sec.
 -duration time - 20 sec.
 -frame sw. - off
 -trigger - negative
REMOTE CONTROL: -off
LINE-LOCK: -phase - 0

SELF TEST

Switch off the unit. Press the key "3" and turn the power on. All video inputs are sequentially switched to the both output channels accompanied with blinking LEDs. Buzzer is activated.

INSTALLATION

This unit is fully assembled prior to shipment, and is ready to operate immediately after unpacking.

If there are any problems in ground loop-through between video sources (cameras, VCR etc.) and this unit, remove the seven screws on

the cover's upper panel and open the upper lid. Then remove the GND connector from PCB. The video switcher ground will be separated from the cover and earth.

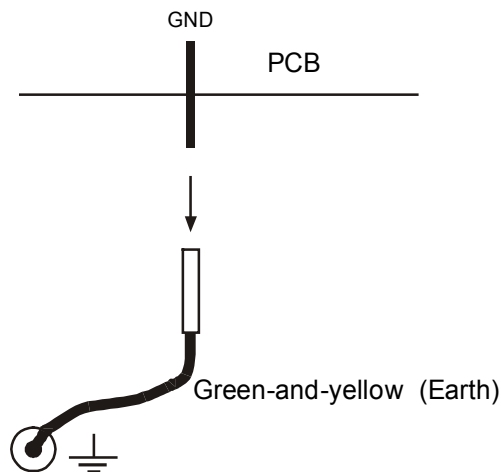

Note:

- When the GND connector is removed it has to be isolated.

TABLETOP UNIT

This unit is fitted with rubber feet on the base plate for use as a tabletop unit.

RACK MOUNTING

For rack mounting, remove the rubber feet and use the optional rack mounting kits.

APPEARANCE

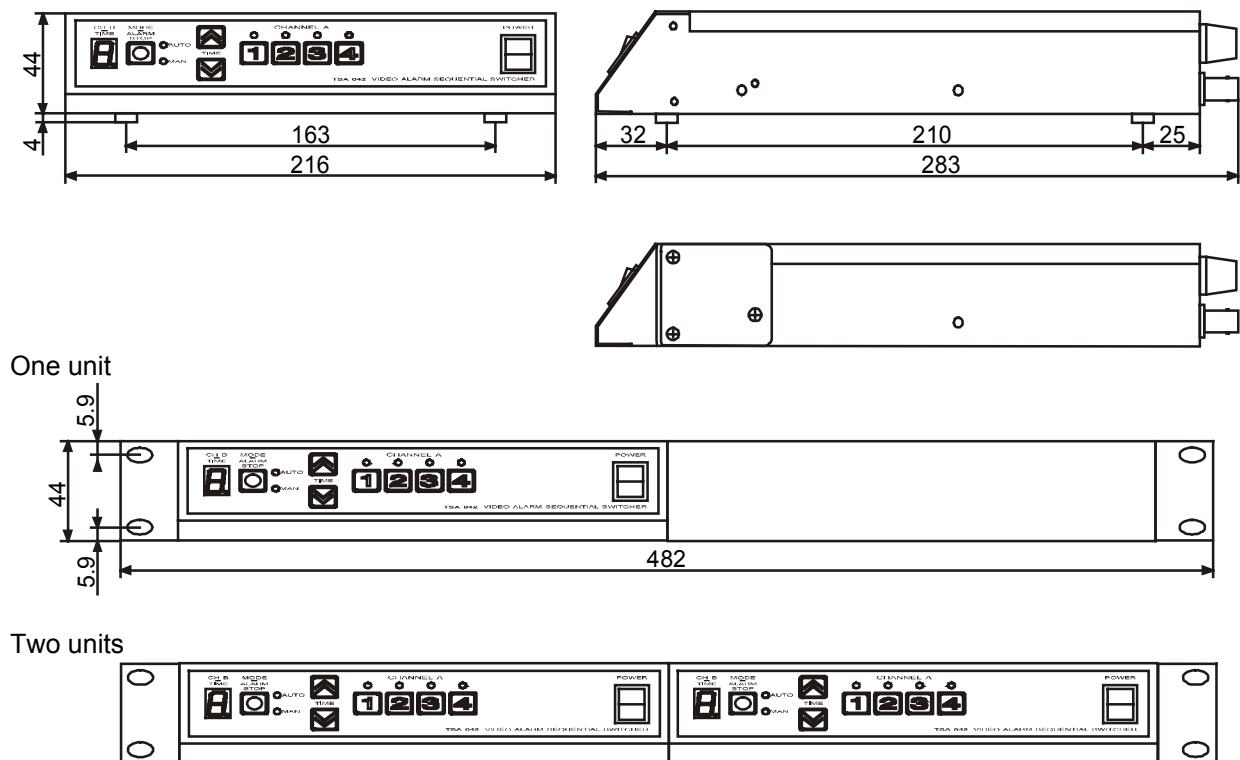

SPECIFICATIONS

Video inputs	4
	1 Vpp / 75 Ω, BNC
Video outputs	2
	1 Vpp / 75 Ω, BNC
Video bandwidth	10 MHz ± 3 dB
Signal / noise ratio	> 60 dB
Crosstalk	56 dB (4.5 MHz)
Switching interval	adjustable, 1 to 90 sec. (CH A, CH B, alarm)
VCR clock input	TTL, negative triggered, terminal block
Frame switching	1 - 99 frames
Line-lock phase	-2.2ms to +2.2ms (-127 steps to +127 steps)
Alarm inputs	4
	activity adjustable, D-9F connector
Alarm output	low-active, open collector, terminal block
Alarm duration	adjustable, 1 to 90 sec. or manual reset
Nonvolatile RAM backup	100 years data retention.
Power requirement	230 V, 50 Hz
Power consumption	max. 8 W
Dimensions (W x H x D)	216 x 44 x 240 mm
Weight	2.5 kg

PIN ASSIGNMENT

Alarm input / remote control connector D-9F:

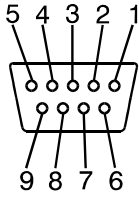

PIN No.	ALARM	REMOTE
1	ALARM 1	T1
2	ALARM 2	T2
3	ALARM 3	n.c.
4	ALARM 4	n.c.
5	n.c.	n.c.
6	n.c.	n.c.
7	n.c.	n.c.
8	n.c.	n.c.
9	GND	GND

Note:

- Pins numbered 5,6,7,8 must be left open.

Alarm output / VCR Clock connector:

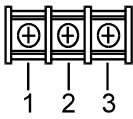

PIN	
1	ALARM OUT
2	GND
3	VCR CLOCK

OPTIONAL ACCESSORY

Rack mount kit

ASTEL d.o.o., Dutovlje 138, 6221 Dutovlje, Slovenia
Tel: +386 5 7310771, +386 5 7310772
Fax: +386 5 7310789
E-mail: sales@astel-cctv.com
Web: www.astel-cctv.com